



GRAND

The complete catalogue

Between us, ideas become reality



GRAND

Design Is

Thinking made visual



Our vision

To be favourite at ever ceiling

Our mission

To be perfered business partner with experience and quality understanding, qualified solution center for all requirement of the suspended ceiling sector, define the agenda with technology and application, sense of variety and esthetic.

Our values

Establishing continuously business relationship depend on trust and prestige.

Giving value to our customers, business partners and staff.

Believing efficient team playing and changing.

Adding value to the sector with our performance.

spreading positive energy which makes our working productive and efficient.

Keeping understanding of the stuff "their own business".

Development our product and service quality continuously.

Accepting responsibility of sharing knowledge, transparency and polity.

Respect to the nature and environment.

**Let's work
together!**



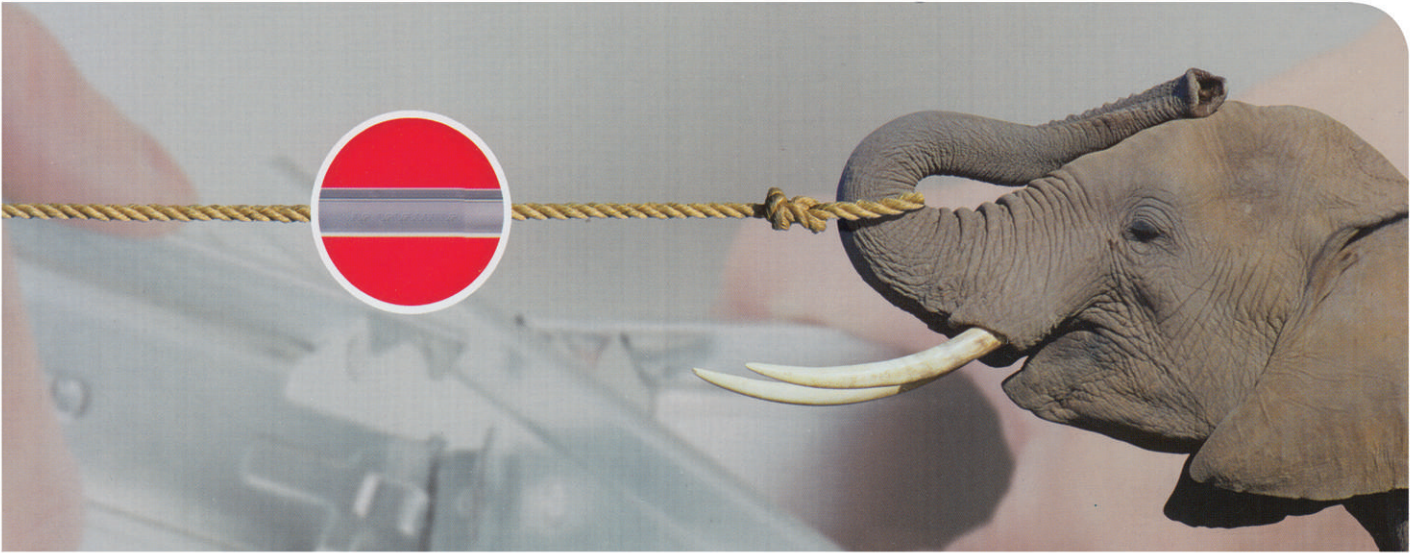

► **Main Carrier**

PRODUCT	Length	Width	Height	Thickness	Pcs/CTN
Main Runner + Fireproof Holes	3,6 m	24	38	0,30	25
Main Runner + Fireproof Holes	3,6 m	24	38	0,35	25
Main Runner + Fireproof Holes	3,6 m	24	38	0,35	25

► **Cross Tee**

PRODUCT	Length	Width	Height	Thickness	Pcs/CTN
Cross Tee + Fireproof Holes	0,6 m	24	38	0,35	75
Cross Tee + Fireproof Holes	1.2 m	24	38	0,35	50
Cross Tee + Fireproof Holes	0.6 m	24	38	0,35	75
Cross Tee + Fireproof Holes	1.2 m	24	38	0,35	50

A For fixing of plasterboard to metal.
 For fixing plasterboard to steel from 0.4mm to 1.0mm thickness.
 Drill point provides easier cutting and faster penetration.
 Available in Black phosphate or Zinc plated.



B For fixing of plasterboard to metal.
 For fixing plasterboard to steel from 1.00mm to 2.5mm thickness.
 Drill point provides easier cutting and faster penetration.
 Available in Black phosphate or Zinc plated.



► **Example**

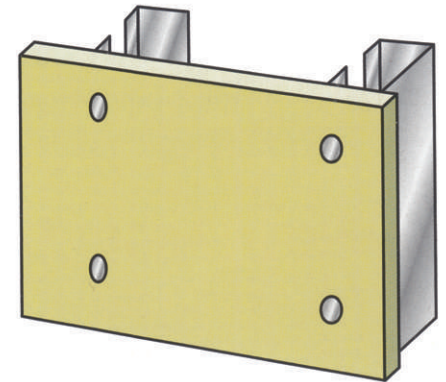
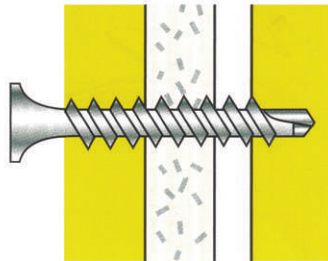
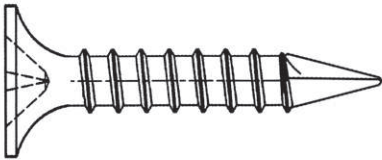

HEAD TYPE	BUGLE HEAD
DRIVE TYPE	CROSS, OR OTHER
THREAD TYPE	TYPE AB

PART NO.	SIZE IFI	SIZE DIN	POINT NO.
BU06000	6# -20x1"-6# -20x2"	3.5-20x25-3.5-20x50	2#
BU07000	7# -19x1"-7# -19x2-1/2"	3.9-19x25-3.9-20x63	2#
BU08000	8# -18x2"-8# --18x3"	4.2-18x50-4.2-18x75	2#,3#
BU10000	10# -16x2"-10# -16x4"	4.8-16x50-4.8-16x100	3#

► **Applications**

1. Brackets.
2. Fixings.
3. Fencing.

► **An Head Self Drilling Screws**

For quick joining of sheet steel to sheet steel without the need for pre-drilling.
 Good for fixing cavity trays, ducting and steel panels.
 Can also be used for temporary fixing.

► **Example**

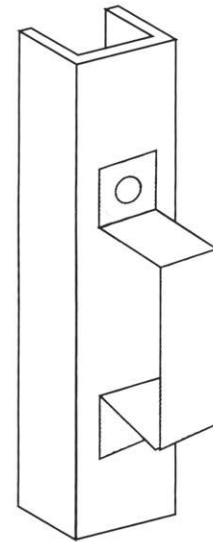
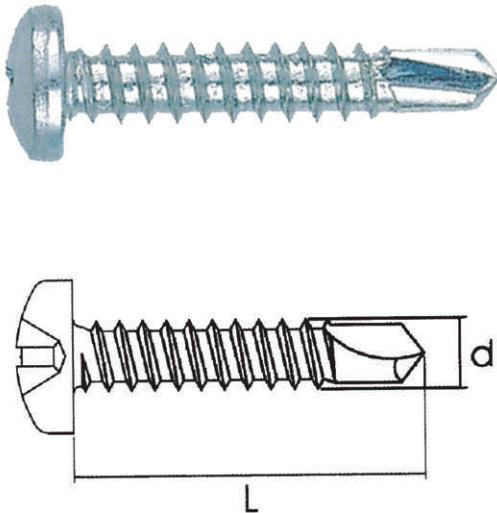

HEAD TYPE	PAN HEAD
DRIVE TYPE	CROSS, OR OTHER
THREAD TYPE	TYPE AB

PART NO.	SIZE IFI	SIZE DIN	POINT NO.
PN06000	6# -20x3/8"-6# -20x3"	3.5-20x9.5-3.5-20x75	2#
PN07000	7# -19x3/8"-7# --19x3"	3.9-19x9.5-3.5-19x75	2#
PN08000	8# -18x3/8"-8# --18x3"	4.2-18x9.5-4.2-18x75	2#,3#
PN10000	10# -16x1/2"-10# -16x4"	4.8-16x13-4.8-16x100	2#,3#
PN12000	12# -14x1/2"-12# -14x5"	5.5-14x13-5.5-14x125	2#,3#,4#
PN14000	14# -14x1/2"-14# -14x8"	6.3-14x13-6.3-14x200	2#,3#,4#

► **Applications**

- 1.Brackets.
- 2.Fixings.
- 3.HVAC, electrical trim accessories to steel framing.
- 4.Residential steel frame construction.
- 5.Hat channel to stud.
- 3.Stud splicing.
- 4.Track to stud.



Fiberglass Self Adhesive Tape

Fiberglass self-adhesive tape is woven from fiberglass bulk yarn, then coated with alkaline resistant glue and adhesive glue. Then cut into different size. This tape is very strong self-adhesive and used in various construction applications.

Specifications:

- 1) Mesh size: 2.85 x 2.85mm (9 x 9 mesh),
3.2 x 3.2mm (8 x 8 mesh) other size as require
- 2) Colors available: white, yellow, grey, silver, blue, black, etc.
- 3) Width: 50 mm, 100mm, 150mm, 200mm, etc.
- 4) Length of roll: 20m 45m 75m 90m 150m etc.or as require.
- 5) Packing: Inner packing: shrink packing or plastic bag, outer packing: 72 rolls/carton or as require.

Packing Details (±5%):

Item	Container Size	Roll/Carton	Loading Quantity
Fiber tape (50mmx90m/Roll)	1x20' GP	24 Rolls/Carton	20000/Rolls

It is made of paper joint tape bonded to two corrosion resistant metal strips and an easy-to-apply polymer reinforcement that eliminates the need to finish drywall corners with metal corner bead. Traditional corner bead is difficult to install, tends to crack and is only available in standard lengths. It can be used on old and new drywall and plaster as well as all inside and outside corners. Flexible Metal Corner Tape is ideal for use in drywall applications: internal or external corners which are 90 degrees or not. High flexibility, replace traditional paper metal flex tape and metal corner bead. Professionals use it for all off angles. Easier and faster installation reduces labor costs. Regular Size: Width: 50mm Length: 10m, 20m, 30m.

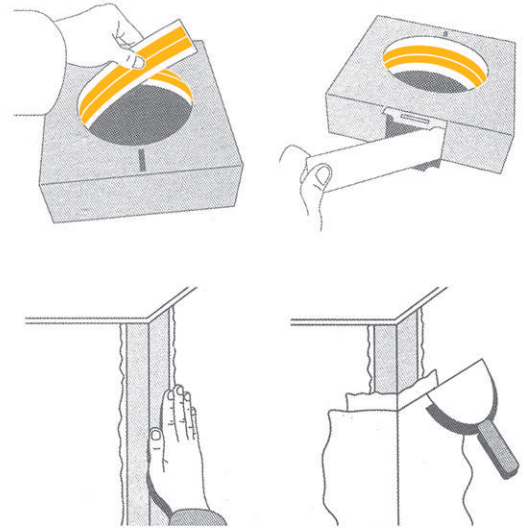

Packing Details (±5%):

Item	Container Size	Roll/Carton	Loading Quantity
Corner tape	1x20' GP	10 Rolls/Carton	11000/Rolls



► Access Panel

All purpose solution, easy access to drywall, suspension ceiling, shaftwall etc. The door frame is made of solid aluminum profile, sturdy hinges with catch wire and hook, the inlay foam seal can be airproof and decrease the decibel. And closing and opening with a push on the door also can remove the door by easy.

► Parameter

200x200mm,300x300mm,400x400mm,500x500mm,600x600mm and specific dimension also can be made as request by customer for example: 600x1200mm.

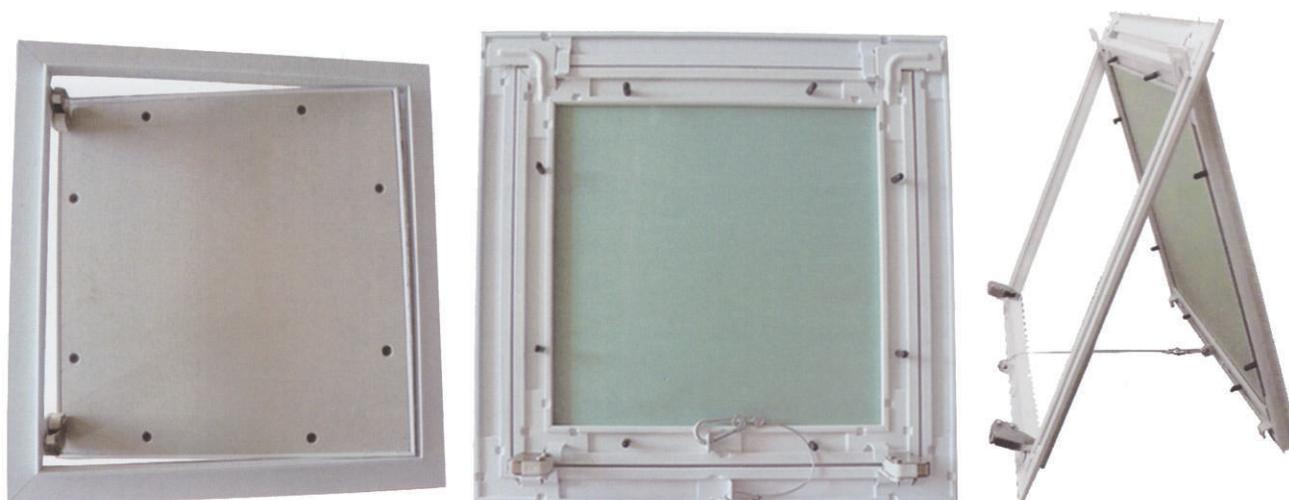

► Packing Details:

Item	Size(mm)	Quantity 1x20'GP	Quantity 1x40'GP	Quantity 1x40'HQ	PCS/Carton
Access panel	200x200	8500/PCS	17500/PCS	20500/PCS	10PCS/CTN
	300x300	4600/PCS	9500/PCS	11100/PCS	10PCS/CTN
	400x400	2850/PCS	5750/PCS	7000/PCS	10PCS/CTN
	450x450	2350/PCS	4900/PCS	5700/PCS	10PCS/CTN
	500x500	1860/PCS	3840/PCS	4500/PCS	6PCS/CTN
	600x600	1350/PCS	2790/PCS	3240/PCS	6PCS/CTN
	900x900	640/PCS	1340/PCS	1560/PCS	2PCS/CTN
	600x1000	840/PCS	1750/PCS	2060/PCS	2PCS/CTN
	600x1200	720/PCS	1480/PCS	1740/PCS	2PCS/CTN

PVC Laminated Gypsum Tile

▶ GRAND PVC LAMINATED GYPSUM TILE are made of incombustible gypsum board, PVC facing as well as Aluminum foil backing. it is ideal indoor decorative materials especially used in areas requiring clean, dust free environment. the Aluminum foiled backing has thermal insulation properties while the PVC facing provide you various choices with different designs.

- ▶ Size: 595x595(mm)
- ▶ Thickness: 8 to 12.5(mm)
- ▶ Facing: High quality PVC
- ▶ Backing: Aluminum Foil
- ▶ Edge: Taped or without tape

▶ Application:

Gypsum ceiling tiles are square-cut and can be easily installed with suspension T-grid system for interior ceiling. they are widely used in all commercial and institutional buildings such as offices, hospitals, schools, restaurants and shops.

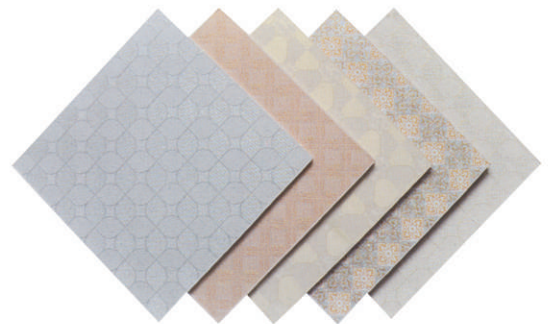
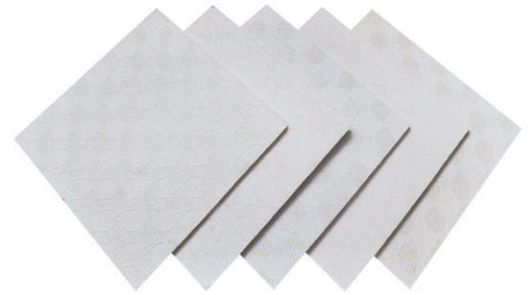

REGULAR 24

Exposed Suspension System 24mm (normal)

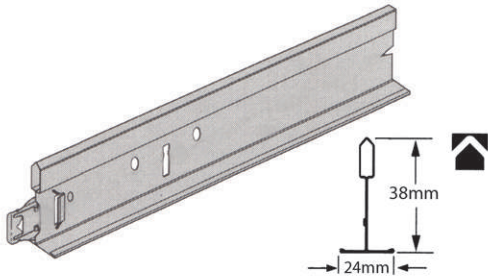

► Regular 24 XL² Cross Tees (stab system, override)

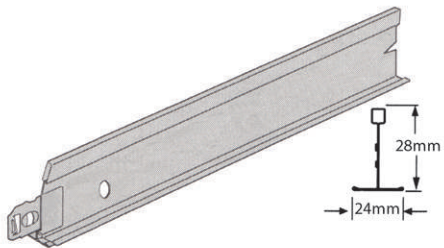
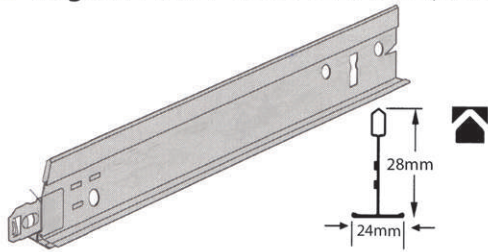

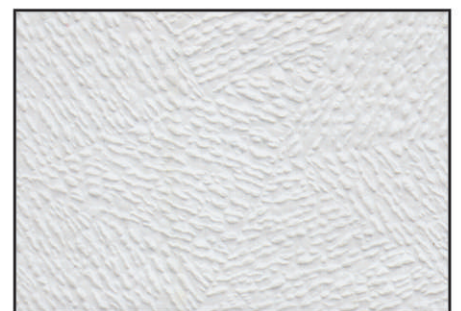
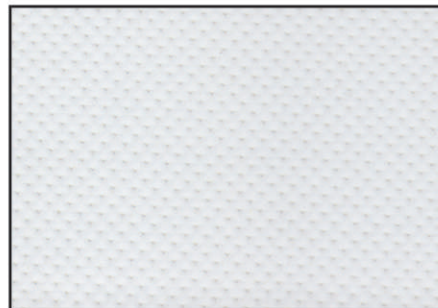
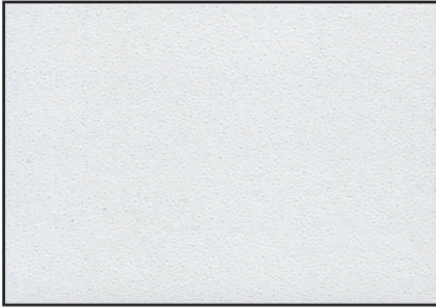

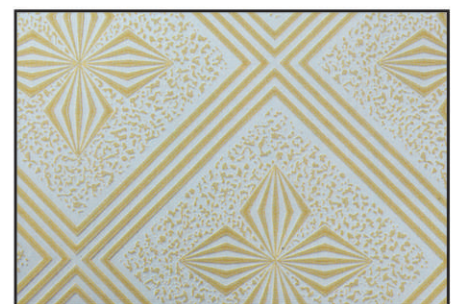
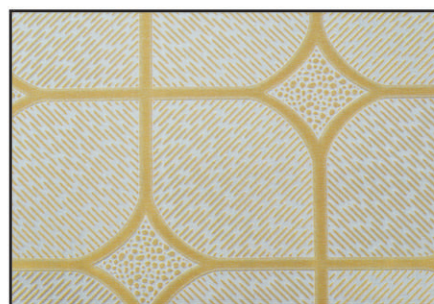
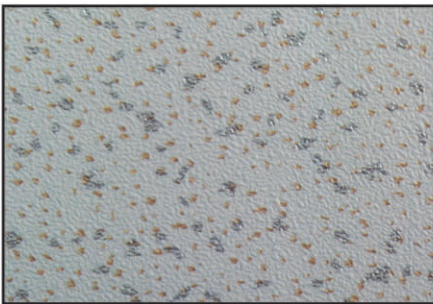
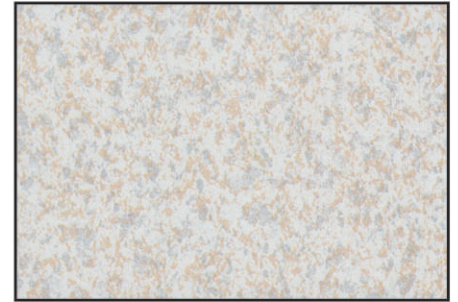
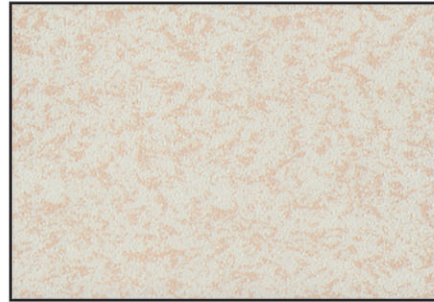
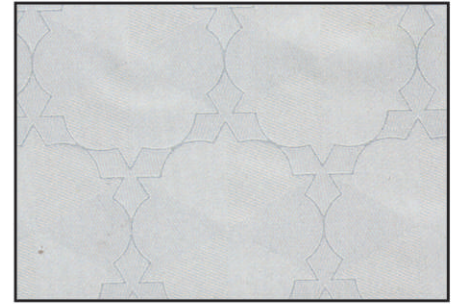

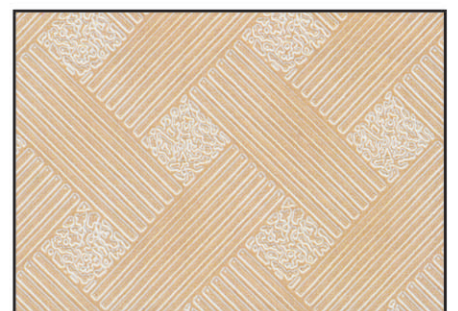
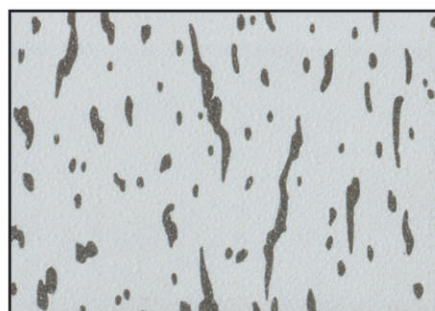
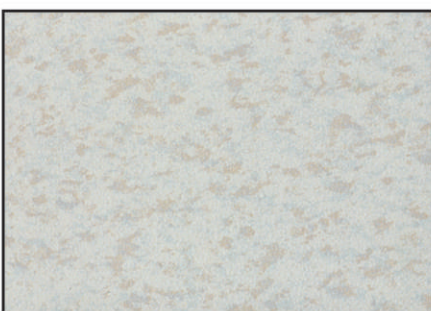
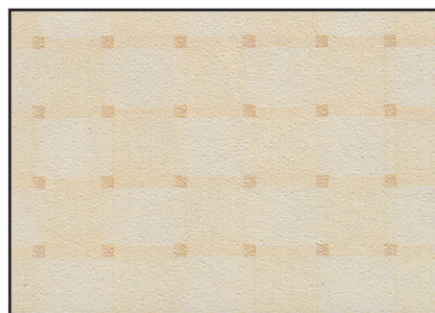
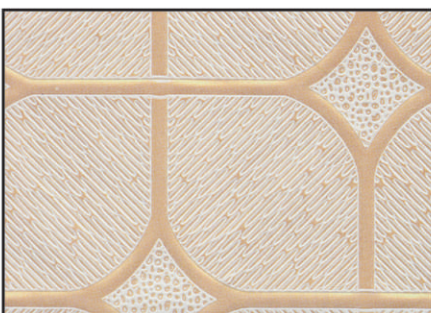
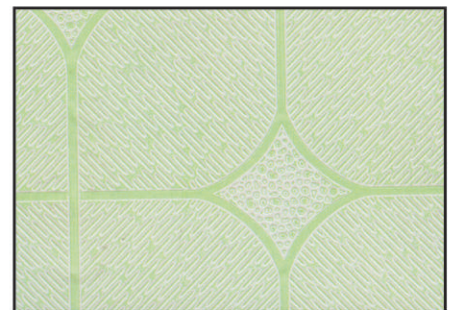
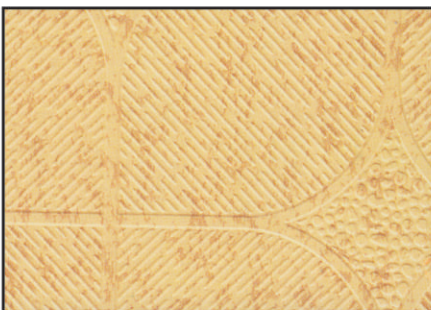
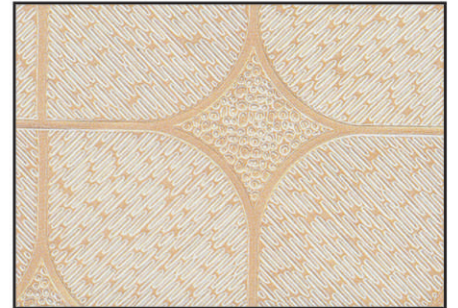
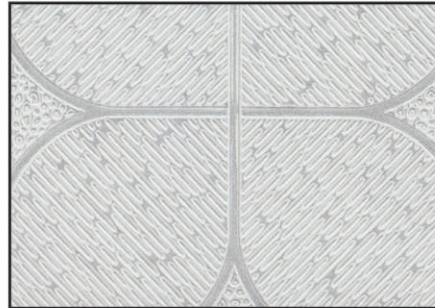
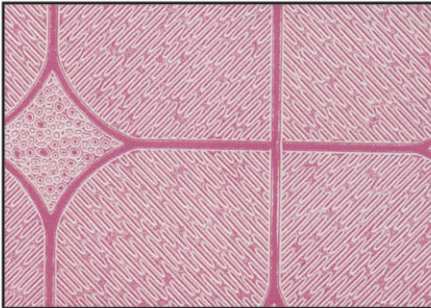
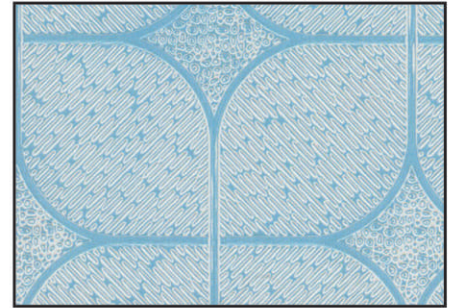
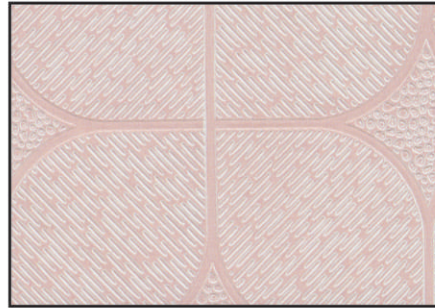

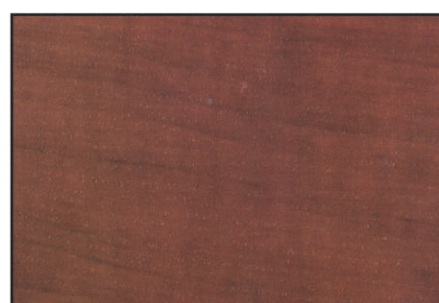
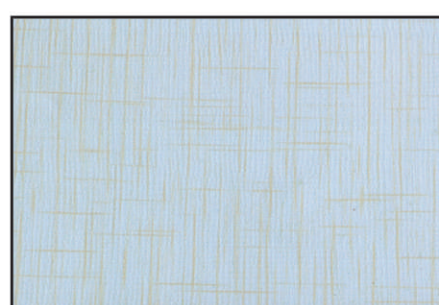
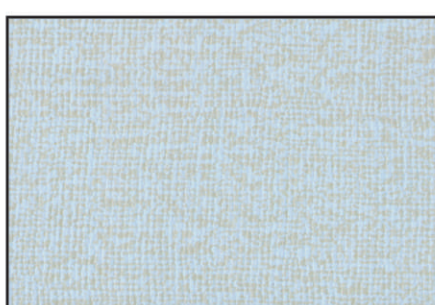
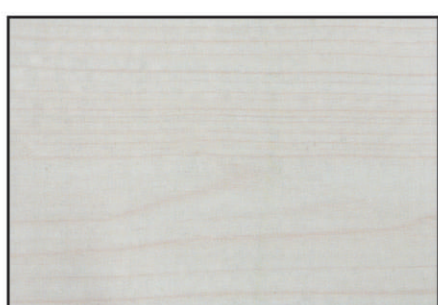
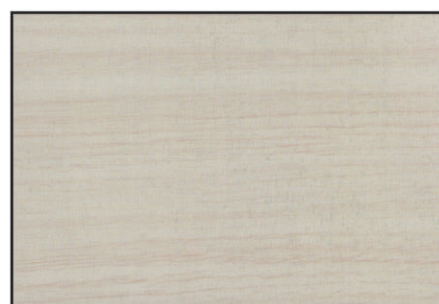
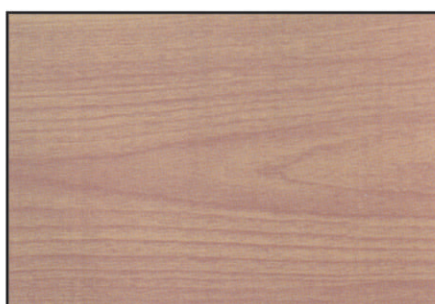
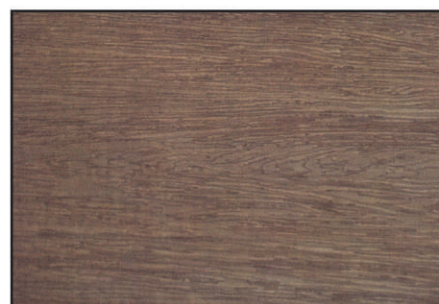
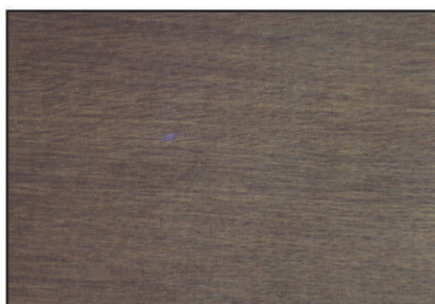
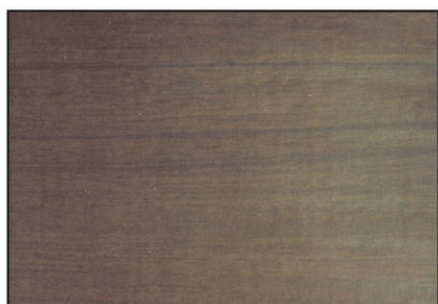
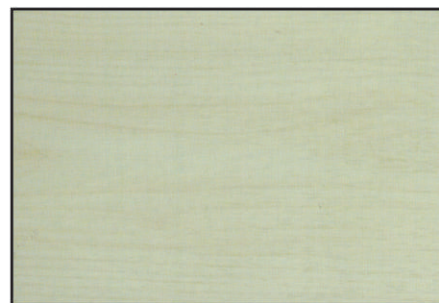



GRAND

Between us, ideas become reality

THE COMPLETE CATALOGUE